

D+CONNECT

REMOTE CONTROL FOR ELECTRONIC
RESIDENTIAL AND COMMERCIAL SYSTEMS



DCONNECT SERVICE

REMOTE CONTROL FOR ELECTRONIC RESIDENTIAL AND COMMERCIAL SYSTEMS

INTRODUCTION

The DConnect service offers simple and intuitive remote control of your installation, without the need of a server or specialist personnel. With DConnect, you can remotely manage your installations as if you were right in front of them.

Thanks to the system operation charts, you will also be able to optimise operation. You will also receive prompt notifications of any system faults.

THE CONNECTIVITY SERVICE ALLOWS YOU TO:

EASILY MONITOR YOUR SYSTEMS

DCONNECT

Installation list

System Name	Status
Impianto di pressurizzazione via Cairoli Pisa	STATUS ✓
Condominio Cancelli Palala	STATUS !
Condominio Pero Livorno	STATUS ✓
Condominio Nicolai Firenze	STATUS !
Officine Arnoldi Pressurizzazione	STATUS ✓
Officine Arnoldi Riscaldamento	STATUS ✓
Officine Arnoldi Acqua Calda Sanitaria	STATUS ✓
Officine Arnoldi gruppi frigo	STATUS ✓

The installations with green status are OK, while the orange ones need attention, and the red ones are experiencing problems

TAKE ANY NECESSARY ACTIONS AS IF YOU WERE RIGHT IN THE PUMP ROOM

Using the internet site or the APPs, you will be able to easily and quickly control your systems.

DCONNECT

Evoplus_Small_Ver_2.xx

Nome: EVOPLUS SMALL
Descrizione Prodotto: Evoplus_Small_Ver_2.xx
Seriale: FJOID-DY4SM-1K111-ORUFW-JDQUW-FT7U902

Ultimo dato ricevuto da **minore di 3m**

Stato

Metric	Value
ERRORE STATO SISTEMA	Sistema OK
PREVALENZA	2.5 m
FLUSSO STIMATO	1.2 m³/h
POTENZA ISTANTANEA	25 W
GIRI AL MINUTO	2213 rpm
ORE FUNZIONAMENTO POMPA	- h
CORRENTE ASSORBITA	192 mA
TEMPERATURA SCHEDA	- °C
TEMPERATURA LIQUIDO	- °C
TEMPERATURA DISSIPATORE	- °C
TENSIONE DI ALIMENTAZIONE	232 V

DCONNECT SERVICE

REMOTE CONTROL FOR ELECTRONIC RESIDENTIAL AND COMMERCIAL SYSTEMS

Connect to the website: <https://dconnect.dabpumps.com>, using Internet Browsers such as Microsoft Edge or Google Chrome.
The Android and iOS DConnect APPs can be downloaded from the relevant Stores:



In order to use the DConnect service, registration and connected products are required.

REMOTE ALARMS

In case of alarm, the DConnect service will promptly send you a notification, so that you can check what is happening and organise a visit to the system before the issue becomes an emergency for your customer.

WHAT PRODUCTS CAN YOU MANAGE USING THE DCONNECT SERVICE?

MCE/P, AD AC, Active driver Plus, E.box, Evoplus, E.sybox, E.sybox mini.

WHAT DO YOU NEED TO USE THE SERVICE?

1. DConnect Box
2. Cables for the connection of the DConnect Box to the products to control
3. One or more compatible products
4. An internet connection in the system to control

For more information visit: <https://dconnect.dabpumps.com/getstarted>

DCONNECT BOX

ELECTRONIC REMOTE CONTROL DEVICE



TECHNICAL DATA

DConnect Box power supply: 12V DC, Current: 1.5A

Power supply unit supplied: input 100-240VAC, with interchangeable plugs for the European, UK Australian and USA markets.

DConnect Box protection class: IP20

Connection to the Internet:

- Wi-Fi: Supports 802.11 b/g/n, WPA-PSK/WPA2-PSK encryption
- Ethernet: Compliant with IEEE802.3 10Base-T and 100Base-TX standards

Installation: DIN rail using the accessory supplied, or wall-mounted installation using the wall plugs supplied.

Maximum number of devices: The maximum number of pumps that can be controlled with DConnect Box is 8.

REQUIREMENTS:

DAB DConnect APP requirements:

Smartphone or Tablet:

- Android 4.4.2 "KitKat" or higher.
- IOs 9 or higher.
- Access to the Internet.

PC requirements:

- Web Browser supporting Java script (e.g. Internet Explorer version 8.0 or higher, Firefox version 7.0 or higher, Google Chrome).
- Access to the Internet.

Network requirements:

- Permanent active local Internet connection.
- Wi-Fi and/or LAN modem/router; active DHCP service.
- In case of Wi-Fi connection, good quality Wi-Fi signal at the DConnect Box installation area. In case of weak signal, we recommended the use of a Wi-Fi signal repeater

APPLICATIONS:

DConnect Box is a compact electronic device that allows to easily connect to the DConnect service a wide range of DAB products, including already installed one. All it requires is a permanent network connection at the place of installation.

Using the DAB DConnect APP, available from Apple Store or Google Play, or connecting to the dconnect.dabpumps.com website, it is possible to go through the various connected installations, checking their individual setting parameters. All this, using an extremely clear and functional user interface that allows you to have a lot of information at your fingertips.

DConnect can be used in all the main fields of application: from pressurisation systems to circulation systems, from waste water recovery installations to swimming pool filtering systems.

It is a multi-channel service of high added value that can be used with any system, irrespective of its nature and size and in the same environment and with the same instruments.

Being modular, DConnect can manage up to 8 different electronic pumps in a highly simple and integrated manner.

DCONNECT BOX

ELECTRONIC REMOTE CONTROL DEVICE

COMPATIBLE PRODUCT CONNECTIONS:

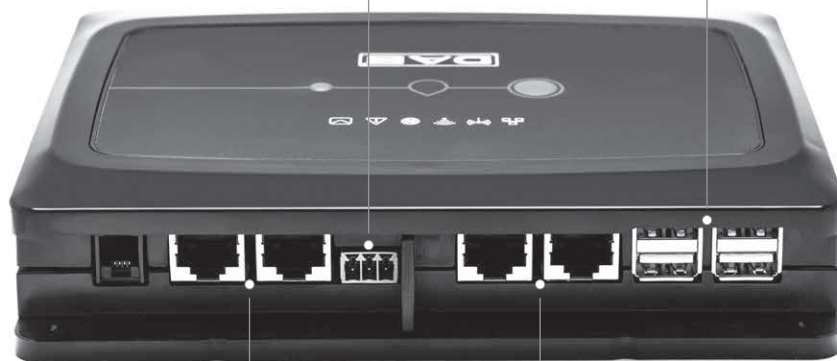





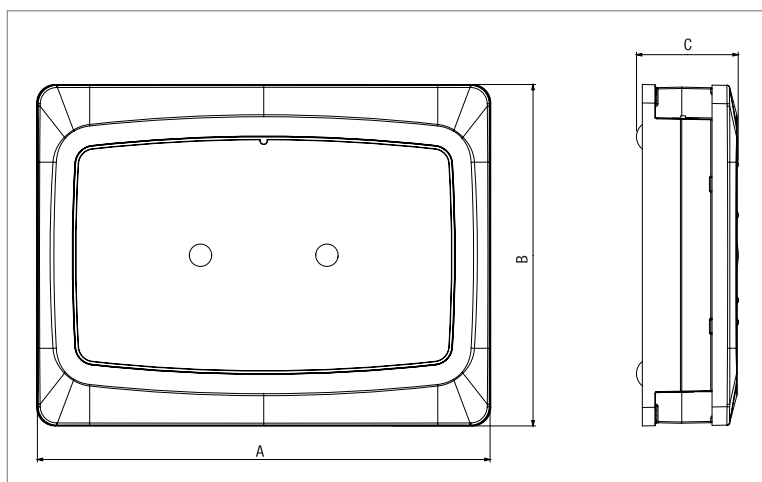

DCONNECT BOX

ELECTRONIC REMOTE CONTROL DEVICE



DIMENSIONS			PACKING DIMENSIONS			WEIGHT kg
A	B	C	L	B	H	
172	129.7	38.6	220	255	145	1.4



	LAN status LED	It shows if the device is connected to the LAN network
	Wireless status LED	If on steady, DConnect Box is communicating with the DAB devices connected through the wireless network
	Wi-Fi status LED	If on, DConnect Box is connected to an Access Point through the Wi-Fi network
		If flashing, DConnect Box is in Access Point mode, for example completing the initial configuration
		If off, DConnect is not connected to an Access Point or Wi-Fi is disabled
	DAB Service Centre connection LED	If on, DConnect Box is connected to the DAB Service Centre
	Generic Error LED	If on, a system error is present
	Message LED	If on, a message has been received, which can be read through the APP or the DAB Service Centre
	DConnect drop LED	Gradually comes on every time data is forwarded to the DAB Service Centre.

DCONNECT BOX

ELECTRONIC REMOTE CONTROL DEVICE

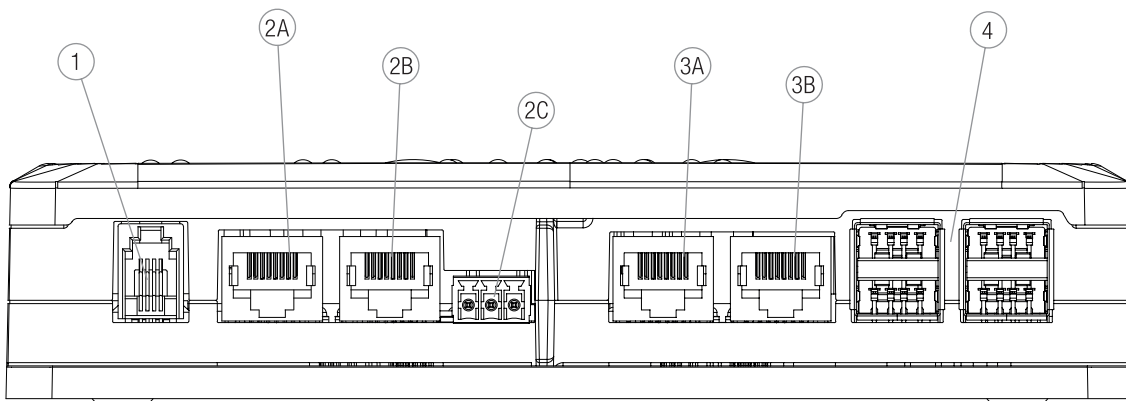

1	Serial Port
2A	ADAC/MCE CAN-BUS1 Port
2B	ADAC/MCE CAN-BUS1 Port
2C	ACTIVE DRIVER PLUS CAN-BUS1 Port
3A	ADAC/MCE CAN-BUS2 Port
3B	ADAC/MCE CAN-BUS2 Port
4	USB EBOX/Expansion Ports

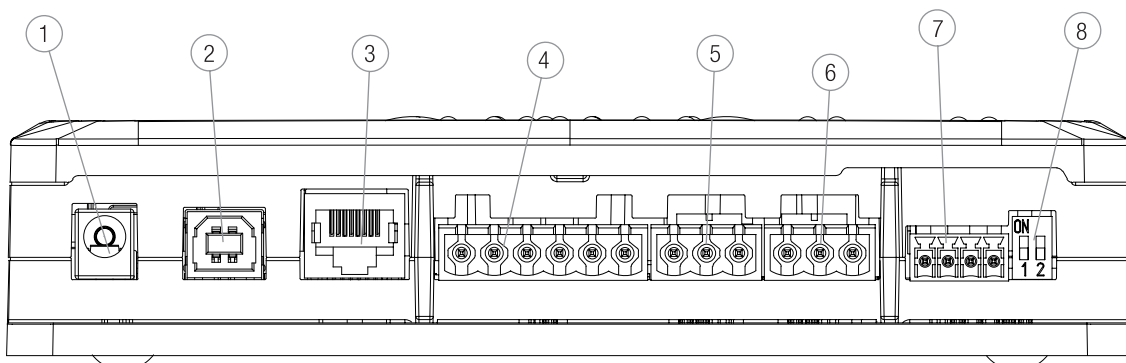

1	Power input / Power Jack
2	Host USB (Power input only)
3	Ethernet Port: LAN cable connection
4	I/O
5	A Relay
6	B Relay
7	Modbus: Evoplus
8	Dip Switch: Modbus configuration

PACK CONTENT:

1. DConnect Box.
2. Wall-mounted power supply unit, plugin socket and ferrite core.
3. Screws and plugs for wall-mounted installation.
4. DIN rail installation bracket.
5. Electric connectors for Modbus, Canbus, I/O, Relay connections.
6. Instruction manual.
7. Quick Guide.

LICENSES: <http://dconnect.dabpumps.com/GPL>

DNA[®]

PUMPS SELECTOR



On-line product selection



DAB PUMPS LTD.

6 Gilbert Court
Newcomen Way
Severalls Business Park
Colchester
Essex
CO4 9WN - UK
salesuk@dwtgroup.com
Tel. +44 0333 777 5010



DAB PUMPS IBERICA S.L.

Calle Verano 18-20-22
28850 - Torrejón de Ardoz - Madrid
Spain
Info.spain@dwtgroup.com
Tel. +34 91 6569545
Fax: + 34 91 6569676



DAB PUMPS SOUTH AFRICA

Twenty One industrial Estate,
16 Purlin Street, Unit B, Warehouse 4
Olifantsfontein -1666 - South Africa
info.sa@dwtgroup.com
Tel. +27 12 361 3997



DAB PUMPS BV

*Hofveld 6 C1
1702 Groot Bijgaarden - Belgium
info.belgium@dwtgroup.com
Tel. +32 2 4668353



DAB PUMPS HUNGARY KFT.

H-8800
Nagykanizsa, Buda Ernő u.5
Hungary
Tel. +36 93501700



DAB PUMPS (QINGDAO) CO. LTD.

No.40 Kaituo Road, Qingdao Economic & Technological
Development Zone
Qingdao City, Shandong Province - China
PC: 266500
sales.cn@dwtgroup.com
Tel. +86 400 186 8280
Fax +86 53286812210



DAB PUMPS POLAND Sp. z o.o.

Ul. Janka Muzykanta 60
02-188 Warszawa - Poland
polska@dabpumps.com.pl



DAB PUMPS B.V.

Albert Einsteinweg, 4
5151 DL Drunen - Nederland
info.netherlands@dwtgroup.com
Tel. +31 416 387280
Fax +31 416 387299



OOO DAB PUMPS

Novgorodskaya str. 1, block G
office 308, 127247, Moscow - Russia
info.russia@dwtgroup.com
Tel. +7 495 122 0035
Fax +7 495 122 0036



DAB PUMPS DE MÉXICO, S.A. DE C.V.

Av Amsterdam 101 Local 4
Col. Hipódromo Condesa,
Del. Cuauhtémoc CP 06170
Ciudad de México
Tel. +52 55 6719 0493



DAB PUMPEN DEUTSCHLAND GmbH

Tackweg 11
D - 47918 Tönisvorst - Germany
info.germany@dwtgroup.com
Tel. +49 2151 82136-0
Fax +49 2151 82136-36



DAB PUMPS INC.

3226 Benchmark Drive
Ladson, SC 29456 - USA
info.usa@dwtgroup.com
Tel. 1- 843-797-5002
Fax 1-843-797-3366



DAB PUMPS OCEANIA PTY LTD

426 South Gippsland Hwy,
Dandenong South VIC 3175 - Australia
info.oceania@dwtgroup.com
Tel. +61 1300 373 677